

The GaGe Octopus™ family of multi-channel digitizers features up to 8 channels in a single-slot PCI card with up to 125 MS/s sampling per channel, and up to 4 GB of on-board acquisition memory. Combine several Octopus cards for up to 64 channels in a single system.

With more than 35 new digitizers to choose from, we offer you many more options than ever before.

APPLICATIONS

Radar Design and Test
Disk Drive Testing
Manufacturing Test
Signal Intelligence
Lidar Systems
Communications
Non-Destructive Testing
Spectroscopy
High-Performance Imaging
Ultrasound Test

Octopus CompuScope 83XX

14-Bit Family of Multi-channel Digitizers for the PCI Bus

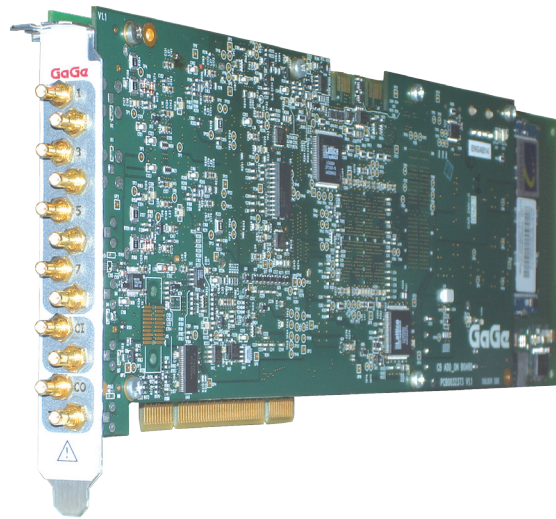

The Octopus family represents a new generation of GaGe digitizers that has all of the advanced features you would expect from a top performance signal capture card:

FEATURES

- 2, 4, or 8 digitizing channels
- 10, 25, 50, 65, 100, or 125 MS/s sampling per channel
- 14 bits vertical resolution
- 128 MS to 2 GS on-board acquisition memory
- More than 100 MHz bandwidth
- Full-size, single-slot PCI card
- Full-featured front-end, with software control over input ranges, coupling and impedances
- 32 bits, 66 MHz PCI standard for 200 MB/s transfer to PC memory
- Ease of integration with External or Reference Clock In and Clock Out, External Trigger In and Trigger Event Out
- Programming-free operation with GageScope® oscilloscope software
- Software Development Kits available for LabVIEW, MATLAB, C/C#

Octopus CompuScope 83XX Simplified Block Diagram

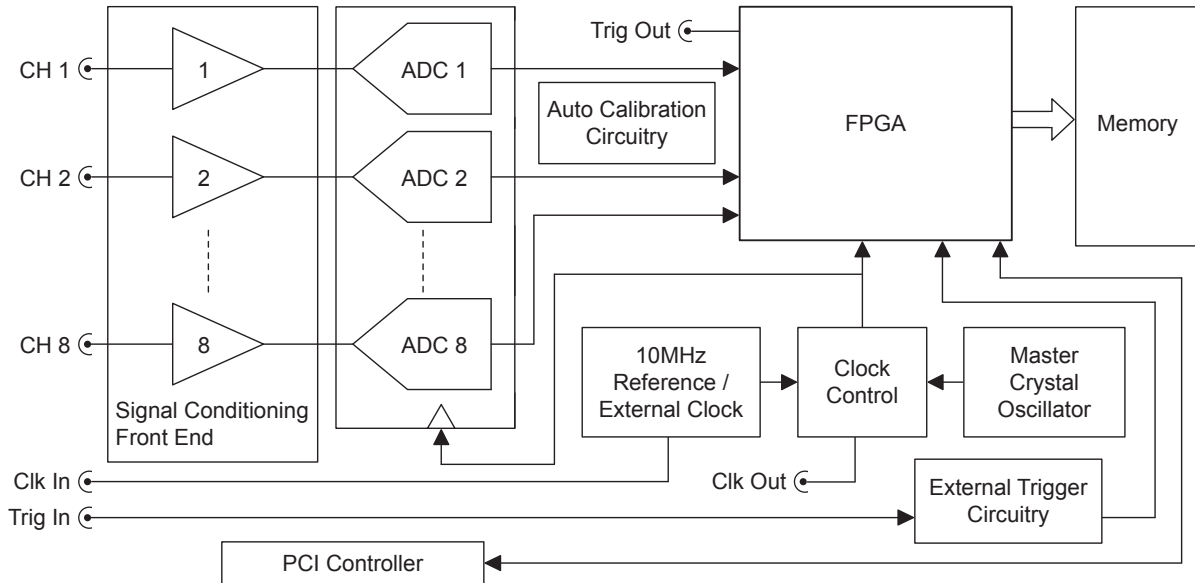

A/D SAMPLING

Number of Inputs:	2, 4 or 8
Resolution:	14 bits
ENOB (see Note 1):	11.0 bits
SNR (see Note 1):	68 dB
SFDR (see Note 1):	80 dB
SINAD (see Note 1):	67.4 dB
Maximum Sampling Rate Per Channel (product-dependent):	10, 25, 50, 65, 100 or 125 MS/s
Sampling Rates (product-dependent):	125 MS/s, 100 MS/s, 65 MS/s, 50 MS/s, 40 MS/s, 25 MS/s, 20 MS/s, 10 MS/s, 5 MS/s, 2 MS/s, 1 MS/s, 500 kS/s, 200 kS/s, 100 kS/s, 50 kS/s, 20 kS/s, 10 kS/s, 5 kS/s, 2 kS/s, 1 kS/s
Connector:	SMB
Impedance:	1 M Ω or 50 Ω ; (software-selectable)
Coupling:	AC or DC; (software-selectable)
AC Coupled Bandwidth:	10 Hz to >100 MHz (see Note 2)
DC Coupled Bandwidth:	DC to >100 MHz (50 Ω see Note 5, slightly less for 1 M Ω)
Flatness (see Note 3):	Within ± 0.5 dB of ideal response to 90 MHz
DC Accuracy (see Note 4):	± 0.5 %
Input Voltage Ranges:	± 100 mV, ± 200 mV, ± 500 mV, ± 1 V, ± 2 V, ± 5 V, ± 10 V (± 10 V is only available in 1 M Ω)
DC Offset	$\pm 1 \times$ Full Range (above ± 5 V is limited to ± 2.5 V)

LOW-PASS FILTER

Type:	3-pole Bessel, 1 per channel
Cut-off Frequency:	24 MHz
Operation:	Individually software-selectable

ACQUISITION MEMORY

Active Channels	Total On-board Memory				
	128 M	256 M	512 M	1 G	2 G
1	128 M	256 M	512 M	1 G	2 G
2	64 M	128 M	256 M	512 M	1 G
4	32 M	64 M	128 M	256 M	512 M
8	16 M	32 M	64 M	128 M	256 M

TRIGGERING

Trigger Engines:	2 per channel, 1 for external trigger
Source:	CH 1 to 8, EXT or Software
Input Combination:	All combinations of sources logically OR'ed
Trigger Level Accuracy:	Less than $\pm 2\%$ of Full Scale for channel triggering
Slope:	Positive or Negative; software-selectable
Sensitivity:	$\pm 2\%$ of Full Scale This implies that signal amplitude must be at least 4% of full scale to cause a trigger to occur. Smaller signals are rejected as noise.
Post-Trigger Data:	128 points minimum. Can be defined with a 64 point resolution.
Maximum Record Length:	Maximum memory depth

EXTERNAL TRIGGER

Impedance:	2 k Ω
Amplitude:	Absolute maximum ± 15 V
Voltage Range:	± 1 V, ± 5 V (software-selectable)
Bandwidth:	>100 MHz
Coupling:	AC or DC
Connector:	SMB

TRIGGER OUT

Impedance:	50 Ω compatible
Amplitude:	0-2.5 V
Connector:	SMB

INTERNAL CLOCK

Accuracy:	± 1 ppm (0 to 50°C ambient)
-----------	---------------------------------

EXTERNAL CLOCK

Maximum Frequency:	Maximum product sample rate
Minimum Frequency:	2 MHz
Signal Level:	Minimum 1 V RMS Maximum 2 V RMS
Termination Impedance:	50 Ω
Sampling Edge:	Rising
Duty Cycle:	50% $\pm 5\%$
Connector:	SMB
Coupling:	AC

EXTERNAL REFERENCE

The External Reference timebase is used to synchronize the Internal Sampling Clock

Frequency:	10 MHz ± 1000 ppm; (software-selectable)
Signal Level:	Minimum 1 V RMS Maximum 2 V RMS
Impedance:	50 Ω
Sampling Edge:	Rising
Duty Cycle:	50% $\pm 5\%$
Connector:	SMB

CLOCK OUT

Maximum Frequency:	Maximum product sample rate
Minimum Frequency:	2 MHz (from External Clock) 1 kHz (from Internal Clock)
Signal Level:	0-2.5 V
Impedance:	50 Ω compatible
Duty Cycle:	50% $\pm 10\%$
Connector:	SMB

MULTIPLE RECORD

Pre-trigger Data:	Up to virtually full record length
Record Length:	128 points minimum. Can be defined with a 64 points resolution.

TIMESTAMPING

Resolution:	One sampling interval
Counter turnover:	>24 hours continuous

CARD SIZE

Single-slot, full-length PCI

SYSTEM REQUIREMENTS

PCI-based computer, minimum Pentium II 500 MHz, with at least one free full-length PCI slot, 128 MB RAM, 100 MB hard disk.

COOLING SYSTEM

Minimum CFM Requirement: *Characterization in progress*

†POWER (IN WATTS, PER CARD)

25.0 W (typical)

†Measured on a typical 4-channel Octopus card.

PCI BUS INTERFACE

Plug-&-Play:	Fully supported
Bus Mastering:	Fully supported
Scatter-Gather:	Fully supported
Bus Width:	32 bits
Bus Speed:	66 MHz or 33 MHz
Bus Throughput:	200 MB/s to PC memory (66 MHz PCI; dependent on motherboard and number of PCI-PCI bridges)
Compatibility:	PCI-compliant, v.2.2 Also v.2.1 systems that supply 3.3 V to PCI slot

MULTI-CARD SYSTEMS

Supported by all Octopus CompuScope models, GageScope, and SDKs.

OPERATING SYSTEMS

Windows Vista, XP:	All Versions
Windows 2000:	SP1 or higher

APPLICATION SOFTWARE

GageScope: Windows-based software for programming-free operation	
LITE Edition:	Included with purchase, provides basic functionality
Standard Edition:	Provides limited functionality of advanced analysis tools, except for Extended Math
Professional Edition:	Provides full functionality of all advanced analysis tools

SOFTWARE DEVELOPMENT KITS (SDK)

CompuScope SDK for C/C# for Windows*
CompuScope SDK for MATLAB for Windows
CompuScope SDK for LabVIEW for Windows

*C/C# SDK is compatible with LabWindows/CVI 7.0+ compiler. Visual Basic.NET support available with purchase of C/C# SDK.

Contact your GaGe Sales Agent for information on Linux support.

WARRANTY

One year parts and labor
Certificate of NIST Traceable Calibration is included.

All specifications subject to change without notice.



Notes to specifications:

- 1) Measured at 125 MS/s in the ±500 mV range with 50 Ω input impedance using a 10 MHz sine wave with an amplitude of 95% of full scale and the on-board filtering capability.
- 2) 10 Hz at 1 MΩ only.
- 3) Measured at 125 MS/s in the ±500 mV range with 50 Ω input impedance with an amplitude of 95% of full scale.
- 4) Measured on ±500 mV, ±1 V, ±2 V input ranges for both 50 Ω and 1 MΩ input impedance settings.
- 5) Measured on ±1 V, ±2 V, ±5 V input ranges using the 50 Ω input impedance setting.

Unless otherwise specified, all dynamic performance specs have been qualified on engineering boards.

ORDERING INFORMATION

Hardware & Upgrades

Octopus 14-bit Family	2 Channel	4 Channel	8 Channel
10 MS/s	CS8320: OCT-832-000	CS8340: OCT-834-000	CS8380: OCT-838-000
25 MS/s	CS8322: OCT-832-002	CS8342: OCT-834-002	CS8382: OCT-838-002
50 MS/s	CS8324: OCT-832-004	CS8344: OCT-834-004	CS8384: OCT-838-004
65 MS/s	CS8325: OCT-832-005	CS8345: OCT-834-005	CS8385: OCT-838-005
100 MS/s	CS8327: OCT-832-007	CS8347: OCT-834-007	CS8387: OCT-838-007
125 MS/s	CS8329: OCT-832-009	CS8349: OCT-834-009	CS8389: OCT-838-009

Memory Upgrade: 128 MS to 256 MS OCT-181-001
 Memory Upgrade: 128 MS to 512 MS OCT-181-003
 Memory Upgrade: 128 MS to 1 GS OCT-181-005
 Memory Upgrade: 128 MS to 2 GS OCT-181-007

36" SMB to BNC male cable ACC-001-001
 36" SMB to BNC male cable - 4 pack ACC-001-003
 6" SMB to BNC female cable ACC-001-011
 6" SMB to BNC female cable - 4 pack ACC-001-013
 6" SMB to SMB jumper cable ACC-001-021
 6" SMB to SMB jumper cable - 4 pack ACC-001-023

eXpert™ Firmware Options
 eXpert Signal Averaging Firmware Option 250-181-001
 eXpert FIR Filtering Firmware Option 250-181-002
 eXpert Peak Detection Firmware Option 250-181-003
 eXpert FFT Firmware Option 250-181-004
 eXpert Firmware Option bundle 888-100-026
 (Signal Averaging, FIR Filtering and Peak Detection)

GageScope® Software
 GageScope: Lite Edition Included
 GageScope: Standard Edition 300-100-351
 (with Purchase of CompuScope Hardware)
 GageScope: Professional Edition 300-100-354
 (with Purchase of CompuScope Hardware)

Software Development Kits (SDKs)
 GaGe SDK Pack on CD 200-113-000
 CompuScope SDK for C/C# 200-200-101
 CompuScope SDK for MATLAB 200-200-102
 CompuScope SDK for LabVIEW 200-200-103

900 N. State St.
Lockport, IL 60441-2200

Toll-Free (US and Canada):
phone 1-800-567-4243
fax 1-800-780-8411

Direct:
phone +1-514-633-7447
fax +1-514-633-0770

Email:
prodinfo@gage-applied.com

To find your local sales representative or distributor or to learn more about GaGe products visit:

www.gage-applied.com

Updated Nov. 17th, 2008

Copyright © 2008 Gage Applied Technologies. All rights reserved.